



Accordion Shutters - Bertha High Velocity System

The Bertha High Velocity Folding Accordion shutter is the most economical and feature packed shutter available on the market today.

Key Features:

- All Extruded Aluminum Construction
- 5-Point Locking Security System
- Silicone Impregnated Wheel Carriages
- Xylem Coated and Stainless Steel Hardware
- 4/5 Standard Colors
- Economical
- Dade County Approved Designs Available
- Mechanically Bent radius tracks to fit any shaped balcony
- Built to withstand hurricane force winds
- Encloses entire balconies with one shutter
- Protect patio doors from rain damage
- Improved Stacking
- More Coverage per Blade
- Fastest Assembly and Installation
- Reduced "footprint" for balcony enclosures



The Vertical Interlocking Blade system gives stability and strength even in the worst possible weather conditions. Each Blade interlocks into the next with a sure locking design and are made from Heavy Duty Extruded Aluminum.

Benefits:

- Accordion Hurricane Shutters are permanently installed for year round protection.
- They fold back compactly similar to a louvered door and are one or two piece shutters.
- They are installed in front windows and doors, balconies, and large patio openings.
- Accordion Shutters are convenient, and easily close. They lock from the inside or outside for increased security and protection.
- Accordion Hurricane Shutters are made of aluminum and should be cleaned and lubricated yearly.
- Accordion Shutters are considered one of the strongest shutters available.



- A Special 90° Corner Mate is available to exactly fit your balcony and not take up valuable floor space.
- The new Big Bertha HV features Hurricane Protection for residential and commercial applications.
- The two-blade system is highly versatile and allows flexible use of components for both commercial and residential Hurricane Shutter Systems.

Approval Numbers:

These Accordion Shutters have been tested to meet or exceed the most stringent requirements for Hurricane Shutters in the industry, such as:

- Florida Building Code (FBC) Non HVMZ
- Florida Building Code (FBC) HVMZ
- Dade and Broward
- International Building Code (IBC)
- International Residential Code (IRC)
- Texas Department of Insurance (TDI)
- Miami-Dade County



BERTHA HIGH VELOCITY ACCORDION STACKING CHART

"ALL DIMENSIONS ARE IN INCHES"

BLADES	OPENING	STACK	FINISHED	BLADES	OPENING	STACK	FINISHED
1	7.00	3.75	10.75	51	157.00	16.25	173.25
2	10.00	4.00	14.00	52	160.00	16.50	176.50
3	13.00	4.25	17.25	53	163.00	16.75	179.75
4	16.00	4.50	20.50	54	166.00	17.00	183.00
5	19.00	4.75	23.75	55	169.00	17.25	186.25
6	22.00	5.00	27.00	56	172.00	17.50	189.50
7	25.00	5.25	30.25	57	175.00	17.75	192.75
8	28.00	5.50	33.50	58	178.00	18.00	196.00
9	31.00	5.75	36.75	59	181.00	18.25	199.25
10	34.00	6.00	40.00	60	184.00	18.50	202.50
11	37.00	6.25	43.25	61	187.00	18.75	205.75
12	40.00	6.50	46.50	62	190.00	19.00	209.00
13	43.00	6.75	49.75	63	193.00	19.25	212.25
14	46.00	7.00	53.00	64	196.00	19.50	215.50
15	49.00	7.25	56.25	65	199.00	19.75	218.75
16	52.00	7.50	59.50	66	202.00	20.00	222.00
17	55.00	7.75	62.75	67	205.00	20.25	225.25
18	58.00	8.00	66.00	68	208.00	20.50	228.50
19	61.00	8.25	69.25	69	211.00	20.75	231.75
20	64.00	8.50	72.50	70	214.00	21.00	235.00
21	67.00	8.75	75.75	71	217.00	21.25	238.25
22	70.00	9.00	79.00	72	220.00	21.50	241.50
23	73.00	9.25	82.25	73	223.00	21.75	244.75
24	76.00	9.50	85.50	74	226.00	22.00	248.00
25	79.00	9.75	88.75	75	229.00	22.25	251.25
26	82.00	10.00	92.00	76	232.00	22.50	254.50
27	85.00	10.25	95.25	77	235.00	22.75	257.75
28	88.00	10.50	98.50	78	238.00	23.00	261.00
29	91.00	10.75	101.75	79	241.00	23.25	264.25
30	94.00	11.00	105.00	80	244.00	23.50	267.50
31	97.00	11.25	108.25	81	247.00	23.75	270.75
32	100.00	11.50	111.50	82	250.00	24.00	274.00
33	103.00	11.75	114.75	83	253.00	24.25	277.25
34	106.00	12.00	118.00	84	256.00	24.50	280.50
35	109.00	12.25	121.25	85	259.00	24.75	283.75
36	112.00	12.50	124.50	86	262.00	25.00	287.00
37	115.00	12.75	127.75	87	265.00	25.25	290.25
38	118.00	13.00	131.00	88	268.00	25.50	293.50
39	121.00	13.25	134.25	89	271.00	25.75	296.75
40	124.00	13.50	137.50	90	274.00	26.00	300.00
41	127.00	13.75	140.75	91	277.00	26.25	303.25
42	130.00	14.00	144.00	92	280.00	26.50	306.50
43	133.00	14.25	147.25	93	283.00	26.75	309.75
44	136.00	14.50	150.50	94	286.00	27.00	313.00
45	139.00	14.75	153.75	95	289.00	27.25	316.25
46	142.00	15.00	157.00	96	292.00	27.50	319.50
47	145.00	15.25	160.25	97	295.00	27.75	322.75
48	148.00	15.50	163.50	98	298.00	28.00	326.00
49	151.00	15.75	166.75	99	301.00	28.25	329.25
50	154.00	16.00	170.00	100	304.00	28.50	332.50

*** THESE ARE CALCULATED WIDTH ONLY - PLEASE VERIFY TRUE WIDTHS ***



Accordion Shutters - Bertha High Velocity

Blade Length Deductions

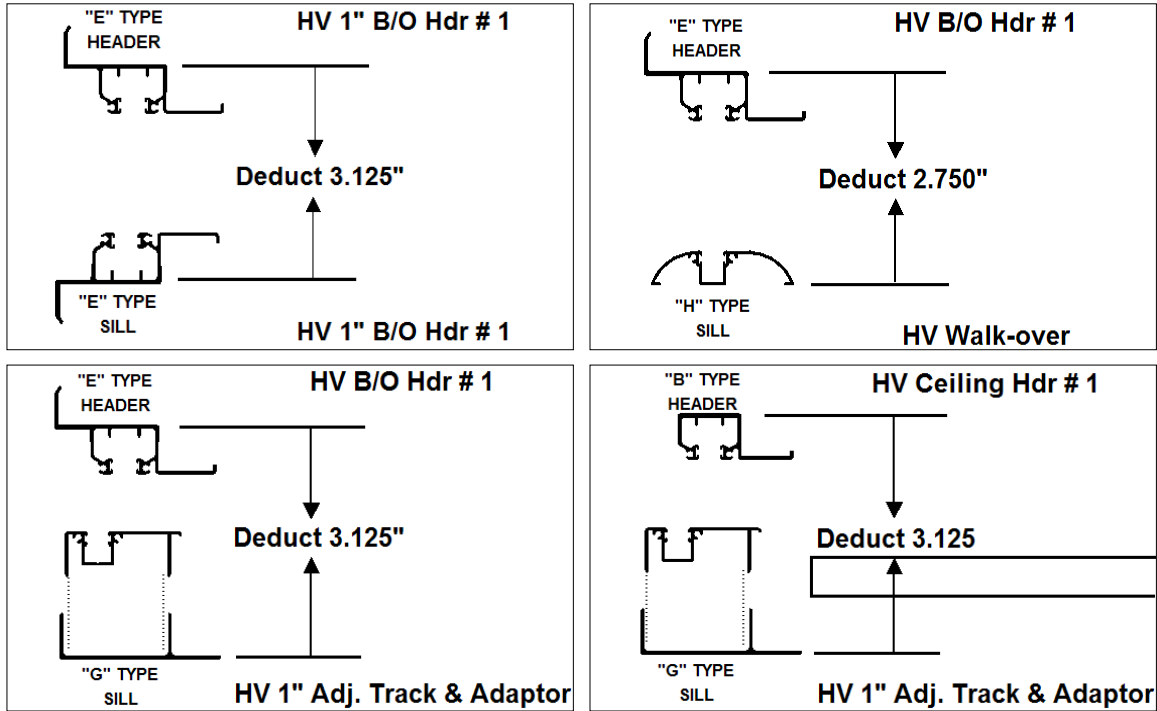



Bertha High Velocity Blades, Rails and Starters

HV BLADE #1

White
Bronze
Ivory
Beige

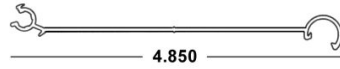

HV CENTERMATE #1

Self Mating
White
Bronze
Ivory
Beige

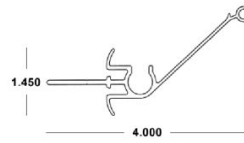

HV FLOATING CENTERMATE #2

White
Bronze
Ivory
Beige

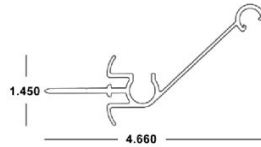

HV CORNER CENTERMATE #3

White
Bronze
Ivory
Beige

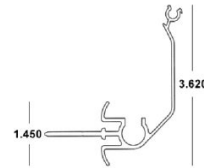

HV ADJ TRACK W/FELT x 20'

With Screw Boss
White
Bronze
Ivory
Beige

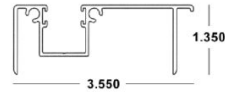

HV SILL ADAPTOR W/LIP x 20'

White
Bronze
Ivory
Beige

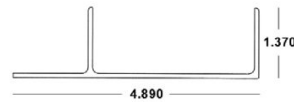

HV WALKOVER TRACK

With Screw Boss
White
Bronze
Ivory
Beige

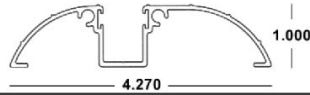

HV 90/180 STARTER

White
Bronze
Ivory
Beige

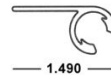

HV 3/8" DIRECT MT STARTER

White
Bronze
Ivory
Beige

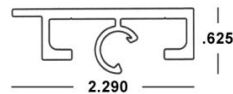

HV 1" DIRECT MT STARTER

White
Bronze
Ivory
Beige

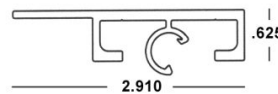

HV 2" DIRECT MT STARTER

White
Bronze
Ivory
Beige



HV CEILING HEADER W/FELT #1

With Screw Boss
White
Bronze
Ivory
Beige

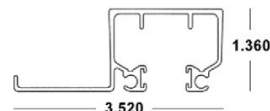

HV 3/8" B/O HEADER W/FELT #1

With Screw Boss
White
Bronze
Ivory
Beige

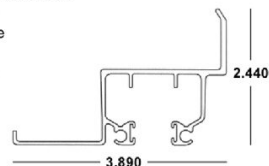

HV 1" B/O HEADER W/FELT #1

With Screw Boss
White
Bronze
Ivory
Beige

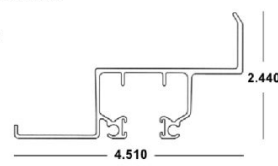



Bertha High Velocity Finished Measurement - Opening Deductions

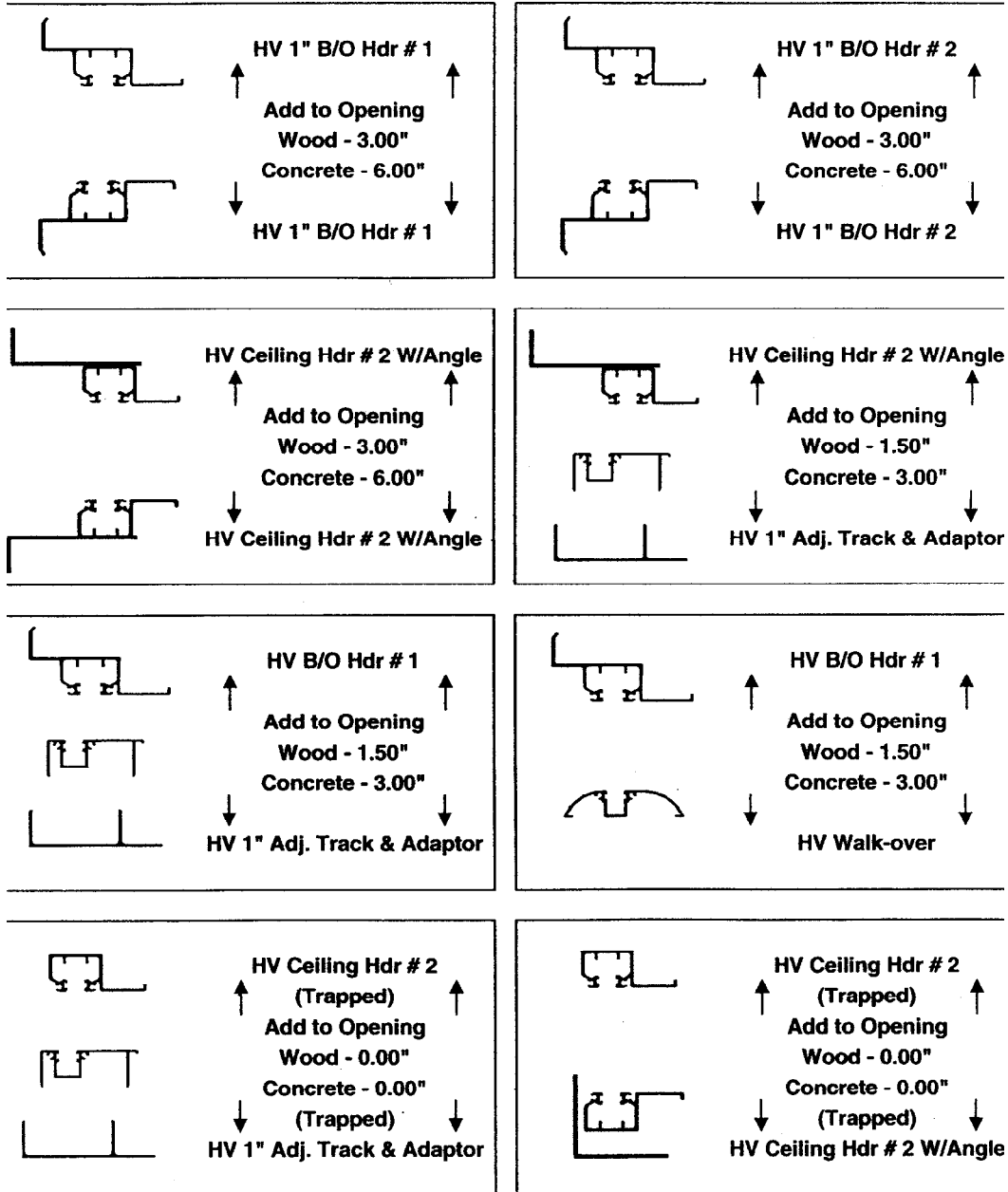



Stretch Formed Accordion Radius Tracks



- CNC Stretched Formed for uniformity
- No more messy Cutting and Welding
- Available in 90 , 120 Degree Bends
- Eliminates the need for 2 Separate stacks which block the view

Exclusive Pricing For Alutech Dealers: 90 degree \$ 285.00
120 degree \$ 330.00

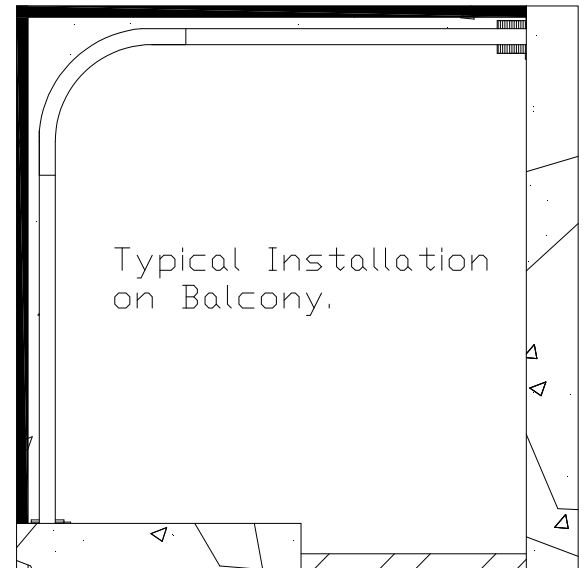
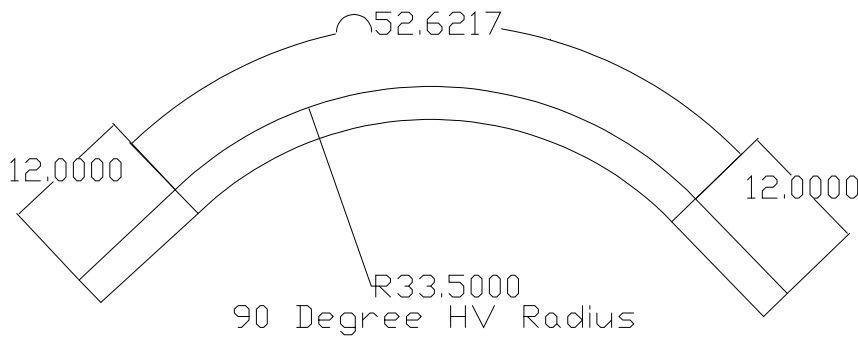
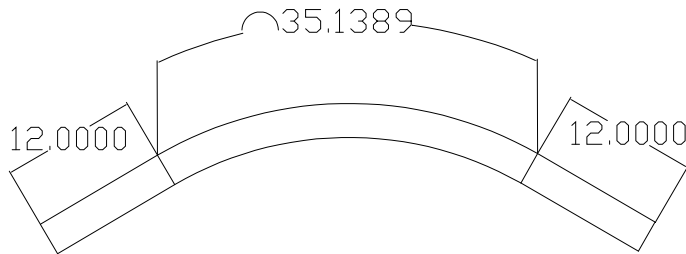

**Above Prices is For (1) pair of Top and Bottom Track, Available in White, Beige, Ivory, and Bronze

**Above Measurements are not Actual, Differences will occur during Bending

Alutech United, Inc.

*The New High Velocity™ (HV) Accordion Shutter
Faster Installation and Assembly Times*



Seven minute elapsed installation